



DW ECO

DW ECO

Application : intérieur et extérieur

Composition :

Intérieur inox 316 Ti - 0,4 mm d'épaisseur
 Extérieur inox 304 - 0,5 mm d'épaisseur
 Isolation 25 mm ROCKWOOL
 Brides de sécurité comprises
 Ø 80 et 100 livrés avec joints

Options :

Brossé : + 15 %
 Couleur RAL : + 25 %



- EN 1856-1
- T200-P1-W-V2-L50050-O00
- T400-N1-W-V2-L50050-O30
- T400-N1-D-V2-L50050-G70
- T600-N1-W-V2-L50050-O50
- T600-N1-D-V2-L50050-G70



jeremias

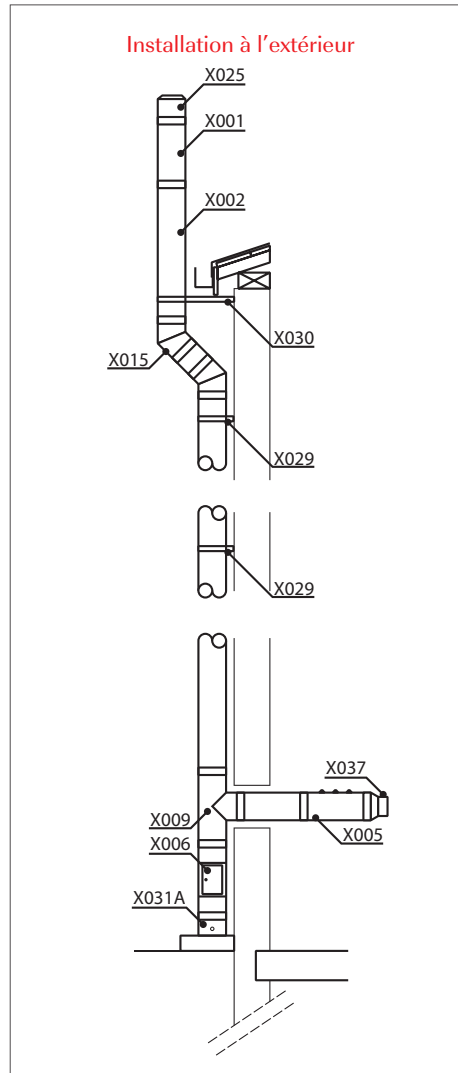

Description du système

Le système de cheminée JEREMIAS double paroi DW ECO est composé d'acier Inox de haute qualité. La qualité du matériau utilisé pour la paroi intérieure est de l'acier Inox 1.4571 (316 Ti) et la qualité du matériau utilisé pour la paroi extérieure est de l'acier Inox 1.4301 (304), matériaux garantissant une longue durée de vie. L'isolation thermique minérale employée est d'une épaisseur de 25 mm.

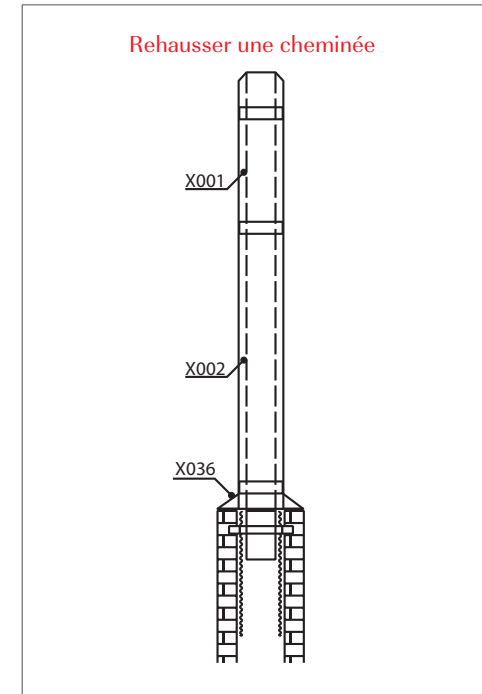
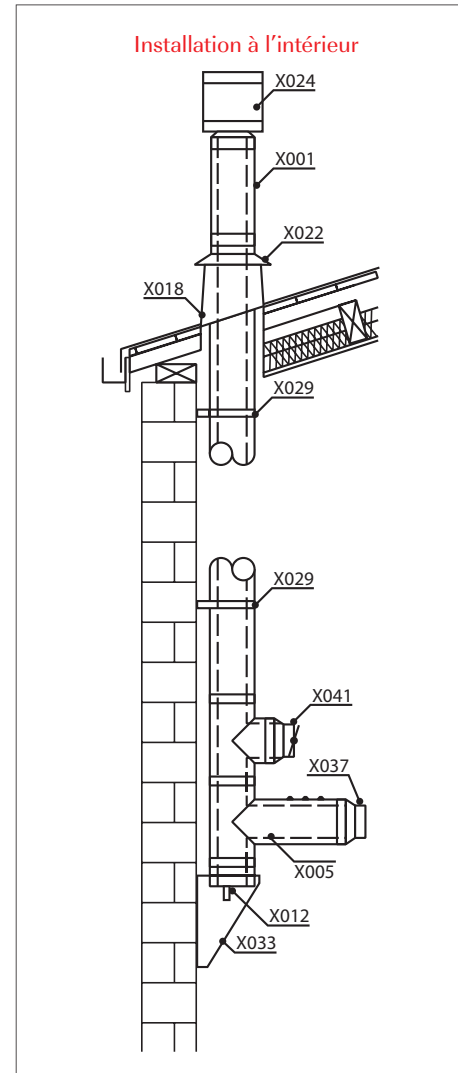



































construction de logements, construction de bâtiments industriels, installations industrielles, installations d'évacuation d'air, conduits de raccordement, évacuation des gaz brûlés. Gaz, fuel et bois. Les conduits JEREMIAS DW Eco conviennent donc à tous les combustibles liquides et solides.

Avantages





































- Résistance à la corrosion grâce à un acier spécial de qualité. Matériau N° 316 TI utilisé sur les parties internes et 304 pour la partie externe.
- Sécurité contre l'inflexion et le voilement obtenu par des épaisseurs de paroi de 0,4 et 0,5 mm.
- Courte occupation de chantier grâce à un montage aisé et rapide.
- Fonctionnement instantané.
- La solution idéale pour les conduits de raccordement, étant donné que tous les éléments longitudinaux peuvent être raccourcis aux dimensions souhaitées sur le chantier.
- Dans de nombreux domaines d'application, la solution d'ensemble la plus rentable pour la cheminée et les conduits de raccordement.

Cet isolant est hautement résistant à la chaleur et a été testé à une température de 450°C lors d'un essai de combustibilité. La qualité d'emploi du système de cheminée JEREMIAS DW ECO est continuellement contrôlée par des offices nationaux compétents. Les éléments de construction préfabriqués en usine sont prêts au montage et peuvent être installés rapidement avec un moindre effort. Le système de cheminée JEREMIAS DW ECO est conçu pour les domaines d'application suivants :

Réf. cde.		Libellé	Ø 80	Ø 100	Ø 130	Ø 150	Ø 180	Ø 200	Ø 230	Ø 250	Ø 300	Ø 350	Ø 400	Ø 450	Ø 500	Ø 550	Ø 600	Réf. emb.	S
X002		Elément 1000 mm	96,57	105,98	110,07	125,37	142,17	157,47	197,22	197,22	252,24	261,81	303,74	329,59	371,63	433,05	449,15	DWECO13	
X001		Elément 500 mm	65,48	71,57	73,39	77,97	85,60	97,85	120,78	120,78	139,11	192,95	213,44	234,01	256,59	322,28	357,10	DWECO14	
X003		Elément 250 mm	48,63	52,09	53,50	59,62	62,67	64,21	79,48	79,48	87,13	135,51	160,12	164,20	180,61	225,77	250,43	DWECO15	
X005		Elément 360 mm + 3 prises tests	-	-	249,93	251,45	256,19	269,63	290,85	290,85	323,82	335,88	365,72	369,49	390,03	451,58	481,45	DWECO90B	
X006B		Elément 360 mm avec inspection	-	-	188,37	202,63	216,83	222,18	252,35	252,35	287,92	357,90	395,58	455,36	518,78	550,50	584,05	DWECO68	
X006C	-	El. 360 mm avec inspection étanche	-	-	249,18	280,32	295,90	317,70	342,62	342,62	373,77	-	-	-	-	-	-	DWECO10R	
X007		Elément ajustable 250 à 480 mm	69,30	76,05	77,88	80,34	84,34	96,65	115,39	115,39	151,39	188,47	257,55	296,72	311,70	339,66	363,88	DWECO50	
X009		Té 90°	129,36	141,86	148,75	177,17	192,34	230,23	257,49	257,49	325,72	391,90	460,92	519,19	621,40	679,23	738,97	DWECO11	
X009B		Té 87° avec trappe	400,76	401,25	427,05	445,80	486,55	532,42	532,42	532,42	616,27	686,29	-	-	-	-	-	-	
X010		Té 135°	-	-	242,54	276,84	313,97	353,21	441,50	441,50	463,68	569,15	668,08	779,65	933,03	1086,05	1181,23	DWECO12	
X010B		Té de démarrage	-	-	242,54	276,84	313,97	353,21	441,50	441,50	463,68	619,97	727,74	849,28	1016,40	1183,04	1286,73	DWECO91	
X011		Tampon sans purge	14,75	16,37	17,97	19,52	21,98	23,33	31,47	31,47	34,11	48,56	57,83	61,59	67,21	70,93	126,50	DWECO43	
X012		Tampon avec purge	31,55	35,08	38,47	40,18	42,64	46,04	48,69	48,69	51,93	67,21	76,51	80,24	85,87	89,58	97,04	DWECO92	
X013	-	Coude 15°	84,91	93,15	96,30	100,05	102,90	118,50	130,86	130,86	171,22	177,66	249,49	274,70	298,93	339,34	371,63	DWECO16D	
X014		Coude 30°	-	-	96,30	100,05	102,90	118,50	130,86	130,86	171,22	177,66	250,46	274,70	298,93	339,34	371,63	DWECO17	
X015		Coude 45°	84,91	93,15	96,30	100,05	102,90	118,50	130,86	130,86	171,22	177,66	250,46	274,70	298,93	339,34	371,63	DWECO18	
X016		Coude 90°	128,95	141,29	148,29	154,41	168,17	171,22	172,76	172,76	206,39	268,26	324,79	345,76	408,81	533,20	597,82	DWECO60	
X016B		Coude 90° + inspection	198,40	216,95	230,23	237,05	250,68	254,11	288,21	288,21	337,67	403,09	468,35	492,70	565,44	709,12	783,72	DWECO19	
X016C	-	Coude 87°	-	-	148,29	154,41	168,17	171,22	172,76	172,76	206,39	268,26	324,79	345,76	408,81	533,20	597,82	DWECO64	



DW ECO

Réf. cde.		Libellé	Ø 80	Ø 100	Ø 130	Ø 150	Ø 180	Ø 200	Ø 230	Ø 250	Ø 300	Ø 350	Ø 400	Ø 450	Ø 500	Ø 550	Ø 600	Réf. emb.	S
X022		Larmier	18,62	20,33	21,98	24,26	25,57	27,29	32,59	32,59	41,30	44,80	44,80	52,28	57,83	72,81	76,51	DWECO307	
V017		Solin 0° inox DW32	Voir gamme TWIN		89,38	94,17	101,17	107,18	122,31	122,31	128,29	185,99	211,37	247,29	287,47	302,27	314,95	DW25B	
V018		Solin 30-45° inox DW32		99,32	105,09	110,93	116,72	142,77	142,77	157,05	185,99	211,37	247,29	287,47	302,27	314,95	DW27B		
V020		Solin 5-30° plomb DW32		138,23	144,42	146,92	151,07	190,99	190,99	192,42	281,10	331,81	369,85	443,85	443,85	517,84	DW56B		
V021		Solin 30-45° plomb DW32		146,50	155,39	168,02	194,52	230,10	230,10	235,67	281,10	331,81	369,85	443,85	443,85	517,84	DW29B		
X023		Chapeau standard	49,64	54,13	58,56	61,03	64,23	71,06	91,89	91,89	109,71	126,92	151,16	173,55	192,16	222,05	242,61	DWECO32B	
X024B		Chapeau anti-pluie	87,00	94,80	102,46	111,41	121,25	134,57	177,00	177,00	208,38	278,64	274,95	391,09	433,66	477,04	520,40	DWECO92H	
X025		Cône de finition	46,72	50,99	55,14	57,60	60,83	71,43	87,74	87,74	106,30	125,04	154,89	173,55	188,47	203,33	227,65	DWECO32	
X026		Bride à suspendre	-	-		21,65	23,80	28,18	32,51	32,51	32,51	33,45	33,45	33,45	33,45	37,91	42,38	DWECO61	
X027		Bride de haubanage	-	-	17,32	19,49	19,49	23,80	26,02	26,02	30,34	31,24	33,45	35,70	35,70	37,91	37,91	DWECO42	
X029		Bride murale normale	16,3	17,79	19,22	21,03	22,02	26,27	27,98	27,98	33,23	35,39	35,39	35,39	37,34	39,20	42,93	DWECO21B	
X030		Bride murale réglable 120-360 mm	32,11	35,13	37,90	44,33	48,69	53,63	59,12	59,12	71,43	70,90	70,90	70,90	74,64	78,36	85,87	DWECO24B	
X031A		Support télescop. 520 mm	74,84	88,94	90,37	97,55	105,55	114,08	121,85	121,85	121,85	149,28	158,63	317,25	363,88	395,58	429,24	DWECO03	
X031B		Support télescopique 1020 mm	115,21	134,65	141,56	150,09	160,30	170,53	199,55	199,55	225,49	272,45	304,17	373,25	434,79	507,57	563,52	DWECO04	
X033		Support mural de départ	73,63	78,84	83,38	94,56	101,19	110,10	125,26	125,26	188,34	223,96	233,27	248,18	270,54	292,98	326,61	DWECO379	
X034		Support de dalle	-	-	46,61	50,97	53,82	58,56	73,14	73,14	82,05	82,11	83,94	83,94	83,94	83,94	83,94	DWECO94B	
W026		Collier soutien gamme souche	-	-	-	40,37	40,37	40,37	43,04	43,04	57,67	-	-	-	-	-	-	DWL188B	
X035		Support de toit	44,10	48,11	52,03	56,35	60,72	65,04	69,36	69,36	73,68	76,51	83,94	83,94	83,94	83,94	83,94	DWECO55	





DW ECO

Réf. cde.		Libellé	Ø 80	Ø 100	Ø 130	Ø 150	Ø 180	Ø 200	Ø 230	Ø 250	Ø 300	Ø 350	Ø 400	Ø 450	Ø 500	Ø 550	Ø 600	Réf. emb.	S
X035B		Support au toit court et pivotant (galva)									34,27							DWECO313	+
X036		Plaque de départ	46,94	46,94	50,59	55,53	58,56	63,48	79,39	79,39	89,25	93,30	102,60	108,22	111,95	121,26	143,72	DWECO127	+
X036B	-	Plaque double à double	54,38	-	-	-	-	93,31	95,21	95,21	-	173,55	181,04	192,16	209,00	227,69	253,79	DWECO08B	+
X037		Connexion double-simple (suivant sens inverse des fumées)	20,95	23,26	20,84	22,19	25,57	27,48	32,77	32,77	37,90	44,80	48,56	50,37	76,51	85,87	93,30	DWECO37	+
X037B		Connexion simple-double (suivant sens inverse des fumées)	22,12	25,12	23,58	25,27	28,77	30,47	35,69	35,69	40,86	44,80	48,56	50,37	76,51	85,87	93,30	DWECO37AM	+
X037D		Connexion multi-emploi 500 mm	-	-	-	163,13	173,97	173,97	-	-	-	-	-	-	-	-	-	DWECO261	+
X037DL	-	Connexion multi-emploi emboîtement 330 mm	-	-	101,26	105,97	114,18	125,66	145,23	145,23	169,55	-	-	-	-	-	-	DWECO95H	+
X037E		Connexion poêle-cheminée	-	-	-	27,10	31,24	33,49	-	-	-	-	-	-	-	-	-	DWECO37F	+
X038		Plaque écart feu	-	-	19,88	22,74	25,79	30,69	34,87	34,87	45,66	63,46	63,46	63,46	65,34	65,34	65,34	DWECO71B	+
W039R		Plaque écart feu pour réhausse de souche	-	-	-	47,69	47,69	47,69	51,67	51,67	67,14	-	-	-	-	-	-	DWL111B	+
X038B		Plaque de finition	19,11	21,29	23,58	25,27	28,77	30,47	35,69	35,69	40,86	43,49	44,44	45,41	47,89	48,90	51,40		+
X038C		Plaque de propreté réglable			28,75	31,01	34,72	37,20	43,80	43,80	51,27	57,35	-	-	-	-	-	DWECO98V	+
X039		Bride de sécurité	9,24	9,80	10,26	10,63	14,22	15,81	19,83	19,83	23,71	-	-	-	-	-	-	DWECO41	+
X041		Régulateur de tirage inox	-	-	115,42	117,10	120,43	122,10	127,11	127,11	132,09	-	-	-	-	-	-	DWECO98B	+
V040		Kit de haubanage (12 m de câble, 6 serre-câbles et 3 tendeurs)									56,04								+
X042		Sortie horizontale chaudière pellet	105,55	142,41	-	-	-	-	-	-	-	-	-	-	-	-	-	DWECO303	+

D'autres réductions sur mesure entre le simple et le double paroi peuvent être réalisées. N'hésitez pas à nous consulter

PC1 : Profile 30 x 30 mm inox de 1 mètre : 17,57 € - PC2 : Profile 30 x 30 mm inox de 2 mètres : 34,14 € - PC3 : Profile 30 x 30 mm inox de 3 mètres : 52,71 € - Réf. cde. : références pour vos commandes - Réf. emb. : références allemandes reprises sur les emballages - • Coude 15° sur demande

